

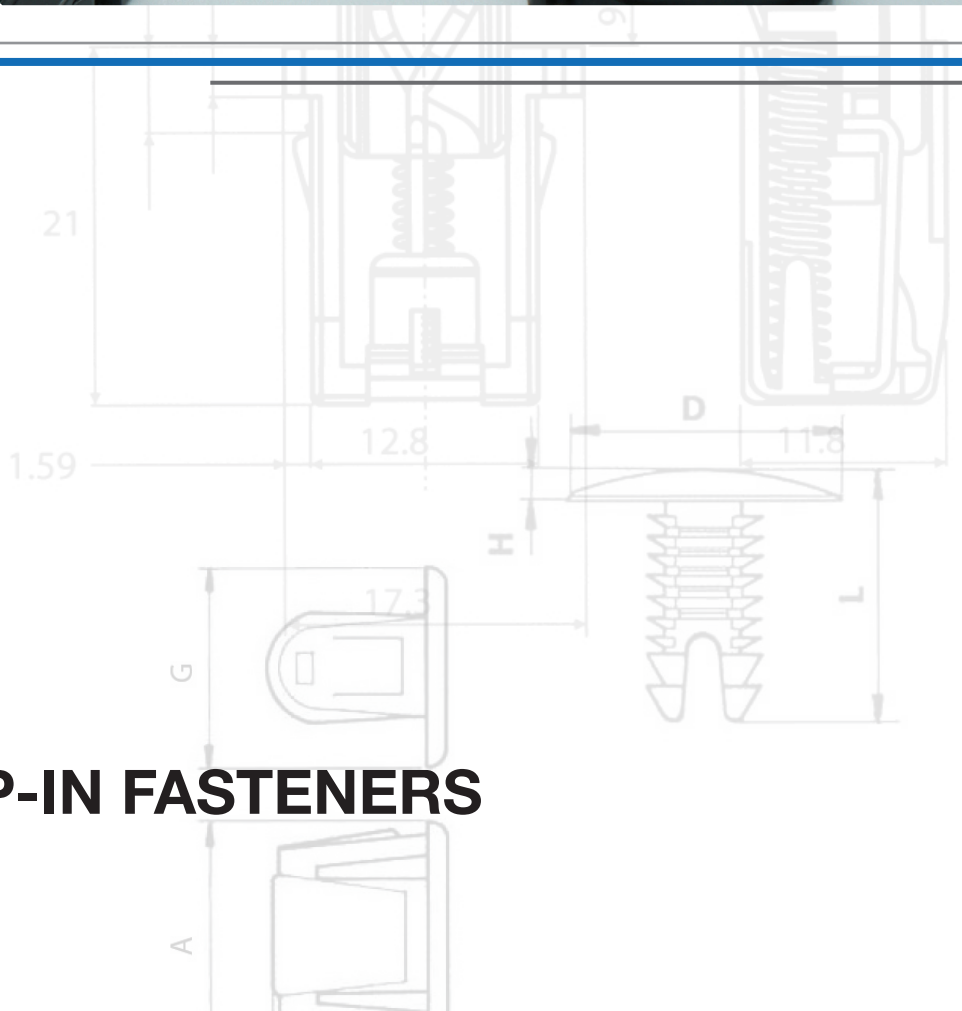

# 8

## SNAP-IN FASTENERS





**Screw grommets**  
*page 8.1*



**Strikes and latches**  
*page 8.4*



**Clips**  
*page 8.8*



**Rivets**  
*page 8.12*



**MATERIAL**  
PA6.6 (Polyamide)

**COLOUR**  
ⓃA Natural

**SELF-EXTINGUISHING**  
UL 94 V-2

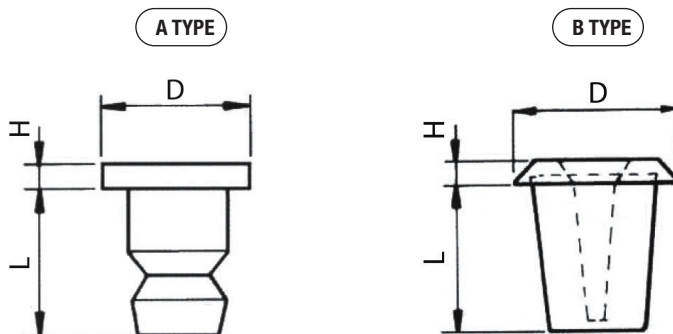

Code ⓃA	D	H	L	Panel hole	Panel thickness	Screw size (D)	Type	Package (pcs)
MFM0707005000	11,5	1,3	10,5	7 x 7	0,5 ÷ 2	4,2	A	5.000

**MFM04** | **ADJUSTABLE SCREW GROMMET**  
closed base



**MATERIAL**  
PA6.6 (Polyamide)

**COLOUR**  
ⓃA Natural  
ⓃE Black

**SELF-EXTINGUISHING**  
UL 94 V-2

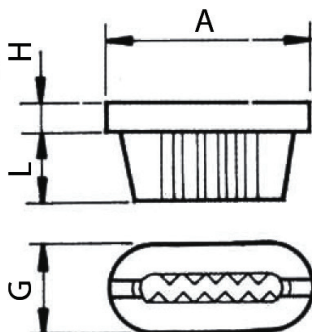

Code ⓃA	Code ⓃE	A	G	H	L	Panel hole	Panel thickness	Screw size (D)	Package (pcs)
MFM0412008000	-	15,5	9	1,2	8,5	12 x 7	0,8 ÷ 2	4,2	5.000
MFM0415008000	-	18	11	1,5	10,5	15 x 7	0,8	3,5	5.000
-	MFM04150080N8	18	10	1,5	8,5	15 x 7	0,8 ÷ 1,2	4,2	2.500

**MATERIAL**

PA6.6 (Poliammide)

**COLOUR**

- NA Natural
- NE Black
- RO Red
- AZ Light Blue

**SELF-EXTINGUISHING**

UL 94 V-2

**OPERATING TEMPERATURE**

-35°C ÷ 85°C

TYPE A

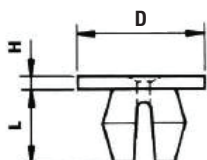

TYPE B

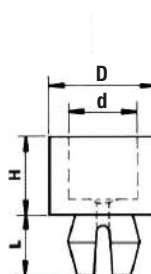

Code <span style="border: 1px solid black; border-radius: 50%; padding: 2px;">NA</span>	Code <span style="border: 1px solid black; border-radius: 50%; padding: 2px;">NE</span>	Code <span style="border: 1px solid black; border-radius: 50%; padding: 2px;">RO</span>	Code <span style="border: 1px solid black; border-radius: 50%; padding: 2px;">AZ</span>	D	d	Panel hole	H	L	Panel thicknessu	Screw size (D)	Type	Package (pcs)
MFM0604505000	-	-	-	5,5 x 5,5	-	4,5 x 4,5	1	5,7	0,5 ÷ 1,5	6	A	28.000
MFM0605505000	-	-	-	9 x 9	-	5,5 x 5,5	1,2	5,8	0,5 ÷ 2	4 ÷ 6	A	5.000
MFM0606305000	-	-	-	9,5 x 9,5	-	6,3 x 6,3	1,2	7	0,5 ÷ 3	6	A	6.000
MFM0607005000	-	-	-	10 x 10	-	7 x 7	1	5	0,5 ÷ 1,5	10	A	5.000
MFM0607005A00	-	-	-	9,5 x 9,5	-	7 x 7	1	8	0,5 ÷ 2,5	8	A	10.000
MFM0607005B00	-	-	-	9,5	-	7 x 7	1	8	0,5 ÷ 3	8	A	10.000
MFM0607005C00	-	-	-	13	-	7 x 7	1	8	0,5 ÷ 3,5	8 ÷ 10	A	5.000
-	-	MFM0607005DO1		9,5 x 9,5	-	7 x 7	1,2	8	0,5 ÷ 4	8	A	12.000
-	-	-	MFM0608007005	11 x 11	-	8 x 8	1,5	7,5	0,7 ÷ 2	10	A	12.000
-	MFM06100070N8		-	12,5 x 12,5	-	10 x 10	1,5	7,5	0,7 ÷ 2	10	A	10.000
MFM0506505000	-	-	-	7	3,7	6,5 x 6,5	3,2	7	0,5 ÷ 3	6 ÷ 8	B	25.000
MFM0507005000	-	-	-	12,5	8,5	7 x 7	4,5	8	0,5 ÷ 4	8 ÷ 10	B	5.000
MFM0507005A00	-	-	-	12,5	8,5	7 x 7	7	8	0,5 ÷ 4	8 ÷ 10	B	10.000
MFM0507005B00	-	-	-	12,5	8,5	7 x 7	10,5	8	0,5 ÷ 4	8 ÷ 10	B	10.000
MFM0507005C00	-	-	-	12,5	8,5	7 x 7	16	8	0,5 ÷ 4	8 ÷ 10	B	5.000
MFM0507005D00	-	-	-	12,5	8,5	7 x 7	20	8	0,5 ÷ 4	8 ÷ 10	B	4.000

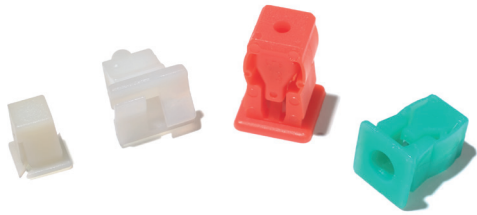

**MATERIAL**  
PA6.6 (Polyamide)

**COLOUR**  
NA Natural  
NE Black  
RO Red  
VE Green

**SELF-EXTINGUISHING**  
UL 94 V-2

A TYPE

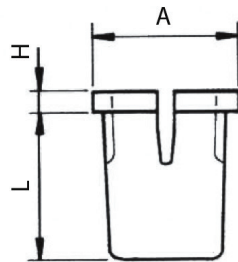

B TYPE

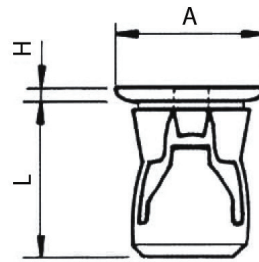

Code <span style="border: 1px solid black; border-radius: 50%; padding: 2px;">NA</span>	Code <span style="border: 1px solid black; border-radius: 50%; padding: 2px;">NE</span>	Code <span style="border: 1px solid black; border-radius: 50%; padding: 2px; color: green;">VE</span>	Code <span style="border: 1px solid black; border-radius: 50%; padding: 2px; color: red;">RO</span>	A	H	L	Panel hole	Panel thickness	Screw size (D)	Type	Pkg. (pcs)
MFM0107006000	-	-	-	9	1	9	7 x 7	0,6 ÷ 1,5	3,5	A	12.000
MFM0107005000	MFM01070050N8	-	-	9,5	1	10,5	7 x 7	0,5 ÷ 1,6	4,2	A	5.000
MFM0108007000	-	-	-	11	0,8	11,5	8 x 8	0,7 ÷ 2	4,2 - 4,8	A	2.500
MFM0109505000	-	-	-	12,5	1,2	18	9,5 x 9,5	0,5 ÷ 2	4,2 - 4,8	A	5.000
MFM0207007000	-	-	-	9	1	12,5	7 x 7	0,7 ÷ 1,5	3,5	B	7.000
-	MFM02080070N8	-	-	11	1,2	14,8	8 x 8	0,7 ÷ 2	4,2	B	3.500
-	-	MFM02090070O6	-	12	1,2	15,8	9 x 9	0,7 ÷ 1,5	4,8	B	2.500
-	-	-	MFM02100070O1	14	1,5	18,5	10 x 10	0,7 ÷ 2	4,8	B	5.000

**MATERIAL**

PA6.6 (Polyamide)

**COLOUR**

NE Black

**SELF-EXTINGUISHING**

UL 94 V-2

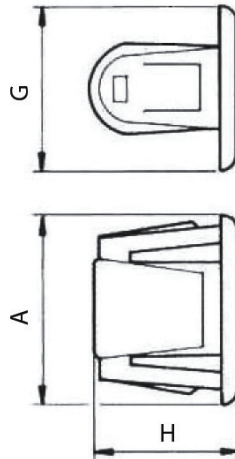
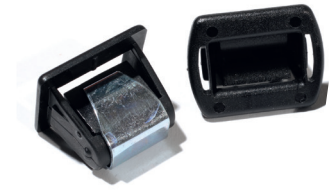

Code NE	A	G	H	Panel hole	Panel thickness	Clip	Package (pcs)
MFH05165100N8	20	18	16	16,5 x 11,5	1 ÷ 1,5	Yes	1.000
MFH05167080N8	23	18	16	16,7 x 11,5	0,8 ÷ 1	Yes	1.000
MFH0516708AN8	23	18	16	16,7 x 11,5	0,8 ÷ 1	No	1.000
MFH05180300N8	25	18	16,5	18 x 13,5	3 ÷ 3,5	Yes	6.000
MFH05180200N8	20	18	16	16,5 x 11,5	2 ÷ 2,5	Yes	5.000

1  
2  
3  
4  
5  
6  
7  
8  
9  
10  
11  
12  
13  
14  
15  
16  
17  
18  
19  
20



**MATERIAL**  
PA6.6 (Polyamide)

**COLOUR**  
NE Black

**SELF-EXTINGUISHING**  
UL 94 V-2

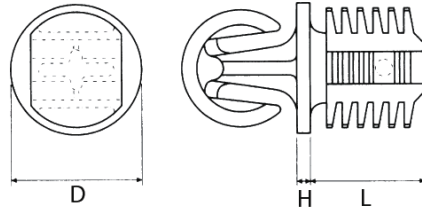

Male

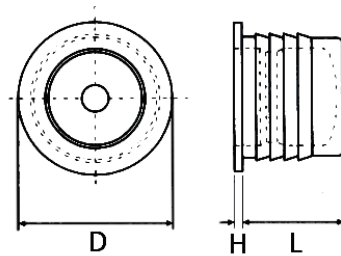

Female

Code NE	D	L	H	Panel hole	Panel thickness	Type	Package (pcs)
MFH01082350N8	9,6	6,5	1	8,25	3,5 ÷ 5,5	Male	15.000
MFH01110300N8	12,7	11,2	1	11 ÷ 11,2	3 ÷ 9	Male	18.000
MFH02103000N8	16	9,5	1,4	10,3	-	Female	15.000
MFH02143000N8	17,8	11,3	1	14,3	-	Female	18.000



**MATERIAL**  
PA6.6 (Polyamide)

**COLOUR**  
NE Black

**SELF-EXTINGUISHING**  
UL 94 V-2

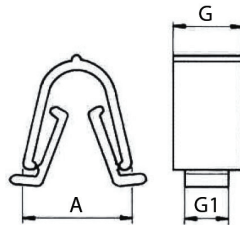
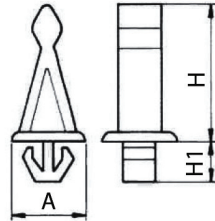
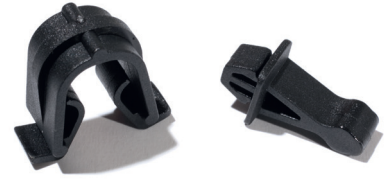

Code NE	A	H	H1	G	G1	Panel hole	Panel thickness	Type	Package (pcs)
MFH03060080N8	11,5	18	6,5	-	-	6 x 6	0,8 ÷ 1,2	Male	2.500
MFH04080080N8	19	-	-	11,8	7,5	8 x 10,5 ÷ 11,5	0,8 ÷ 1	Female	2.500

- 1
- 2
- 3
- 4
- 5
- 6
- 7
- 8
- 9
- 10
- 11
- 12
- 13
- 14
- 15
- 16
- 17
- 18
- 19
- 20





**MATERIAL**  
 POM (Acetal resin)  
 PA (Polyamide)  
 AA (Harmonic steel)

**COLOUR**  
 Black

**SELF-EXTINGUISHING**  
 UL 94 V-2

**OPERATING TEMPERATURE**  
 -30°C ÷ 80°C

TYPE A

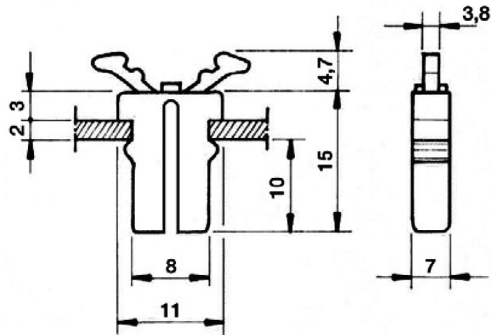

TYPE B

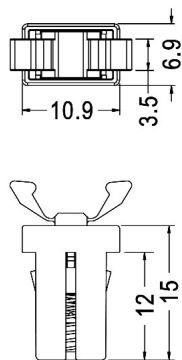

Code 	Panel thickness	Opening/Closure force (N)	Type	Package (pcs)
MFH06002000N8	2	2 - 5	A	1.000
KGH01708015N8	2	2 - 5	B	1.000

**MATERIAL**

PA6.6 (Polyamide)

**COLOUR**

Natural

Black

**SELF-EXTINGUISHING**

UL 94 V-2

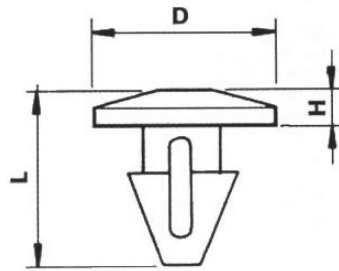

Code 	Code 	D	H	L	Panel hole	Panel thickness	Package (pcs)
-	<b>MFC0503210000</b>	7,3	1,7	11,9	3,2 ÷ 3,5	1 ÷ 2,5	5.000
<b>MFC04045300N8</b>	-	8	1	10	4,5	3	30.000
<b>MFC04065450N8</b>	-	10	1,5	11	6,5	4,5	25.000
-	<b>MFC0406530000</b>	10	1,5	12	6,5	3	20.000
<b>MFC06045700N8</b>	-	10	1,5	14,5	4,5	7	5.000
<b>MFC04060450N8</b>	-	10 x 18	2	13	6	4,5 ÷ 5	21.000
<b>MFC07065B00N8</b>	-	12	1	20	6,5	11	2.500
<b>MFC04060500N8</b>	-	12,3	2	15	6	5 ÷ 6	2.500
<b>MFC0406035AN8</b>	-	14	2	12,5	6	3,5	12.500
<b>MFC04065850N8</b>	-	15	2,5	19	6,5	8,5	18.000
<b>MFC0604570AN8</b>	-	20	1,5	14,5	4,5	7	10.000



**MATERIAL**  
PA6.6 (Polyamide)

**COLOUR**  
NE Black

**SELF-EXTINGUISHING**  
UL 94 V-2

A TYPE

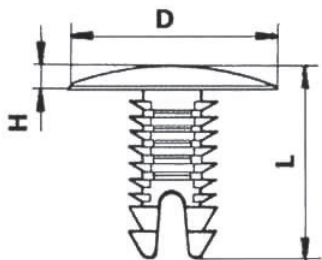

B TYPE

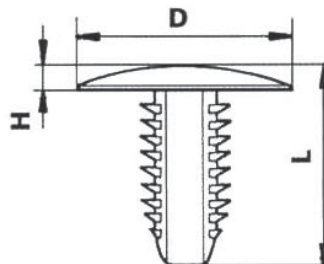

Code NE	D	H	L	Panel hole	Panel thickness	Type	Package (pcs)
MFC02065080N8	18	2	21	6,5	0,8 ÷ 11	A	2.500
MFC02069100N8	18	2	30	6,9	1 ÷ 23,5	A	5.000
MFC02080100N8	18	2	27	8	1 ÷ 16	A	5.000
MFC03038350N8	8	1,5	18,5	3,8	3,5 ÷ 12	B	5.000
MFC03080150N8	22	3,7	23,2	8	1,5 ÷ 12	B	5.000

**MATERIAL**

PA6.6 (Polyamide)

**COLOUR**

NE Black

GR Grey

**SELF-EXTINGUISHING**

UL 94 V-2

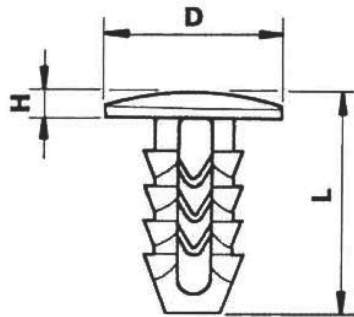

Code NE	Code GR	D	H	L	Panel hole	Panel thickness	Package (pcs)
MFC08052420N8	-	12	2	21,6	5,2	4,2 ÷ 13,3	6.000
MFC08065250N8	-	15	2	14,5	6,5	2,5 ÷ 7,5	10.000
MFC0806530AN8	-	15	2	15	6,5	3 ÷ 8	12.000
MFC0806530BN8	-	15	2	19	6,5	3 ÷ 12	7.000
MFC08065600N8	-	15	2	25	6,5	6 ÷ 18	16.000
MFC08050180N8	-	15	2,2	16	5	1,8 ÷ 10	10.000
MFC08080350N8	-	16	2	19	8	3,5 ÷ 11	16.000
-	MFC08080480O4	18	2	24,5	8	4,8 ÷ 16	12.000
MFC0809040BN8	-	18	2,5	24,5	9	4 ÷ 18	4.000
MFC08090400N8	-	19,5	2,5	21,5	9	4 ÷ 14	9.000
MFC08065300N8	-	20	2	12	6,5	3 ÷ 6	7.000
MFC0806525AN8	-	20	2	14,5	6,5	2,5 ÷ 7,5	3.000
MFC0806530CN8	-	20	2	19	6,5	3 ÷ 12	13.000
MFC0806560AN8	-	20	2	25	6,5	6 ÷ 18	12.000
MFC0808035BN8	-	20	2	26,5	8	3,5 ÷ 18,5	9.000
MFC08065450N8	-	20	2	31	6,5	4,5 ÷ 22,5	4.000
MFC0806560CN8	-	20	2	31	6,5	6 ÷ 24	4.000
MFC08080250N8	-	20	3,2	20	8	2,5 ÷ 10,5	10.000
MFC0809040AN8	-	22	2,5	24,5	9	4 ÷ 16	6.000
MFC08085400N8	-	22	2,5	27,5	8,5	4 ÷ 19	5.000
MFC0808035AN8	-	24	2	19	8	3,5 ÷ 11	5.000
MFC0806560BN8	-	25	2	25	6,5	6 ÷ 18	8.000
MFC0809040CN8	-	30	2,5	27,5	9	4 ÷ 19	1.200



**MATERIAL**  
PA6.6 (Polyamide)

**COLOUR**  
 NA Natural  
 BI White

**SELF-EXTINGUISHING**  
UL 94 V-2

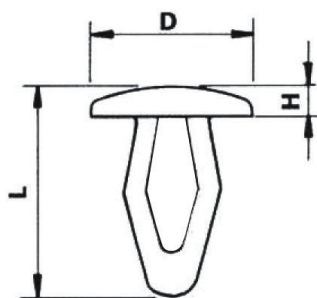

Code (NA)	Code (BI)	D	H	L	Panel hole	Panel thickness	Package (pcs)
MFC0105015000	-	9,5	1,5	12,5	5	1,5 ÷ 3	5.000
-	MFC01035100N9	10	2,5	13,5	3,5	1 ÷ 4	10.000
FG0000006FMB1	-	7,4	1,2	9,7	3 ÷ 3,2	2 ÷ 3,5	2.000



**MATERIAL**  
PA6.6 (Polyamide)

**COLOUR**  
Ⓝ Natural  
Ⓝ Black

**SELF-EXTINGUISHING**  
UL 94 V-2



A TYPE

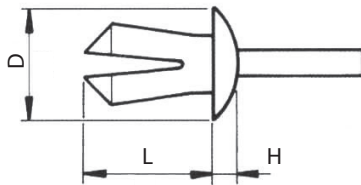

B TYPE

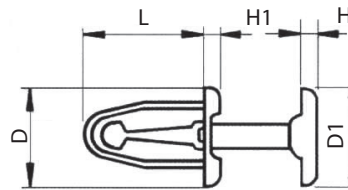

Code Ⓝ	Code Ⓝ	D	D1	H	H1	L	Panel hole	Panel thickness	Type	Package (pcs)
-	KGV03400790N8	6,5	-	1,5	-	7,9	4,0	1,5 ÷ 6	A	1.000
MFV0105520000	MFV01055200N8	9,5	-	2	-	11,8	5,5	2 ÷ 7,5	A	5.000
-	MFV01065350N8	14	-	2	-	15	6,5	3,5 ÷ 11	A	2.500
-	MFV01065550N8	15	-	2	-	12	6,5	5,5 ÷ 9,5	A	2.500
-	MFV01055201N8	16	-	2	-	10	5,5	2 ÷ 6	A	2.500
-	MFV01080300N8	16	-	2	-	13	8	3 ÷ 6	A	1.000
-	MFV01065500N8	23	-	2,5	-	12	6,5	5 ÷ 8	A	4.500
MFV0205514000	MFV02055140N8	10	10	1,6	1,6	14,5	5,5 ÷ 6,5	1,4 ÷ 2	B	18.000
-	MFV02065100N8	10	10	1,6	1,6	18,4	6,5	1 ÷ 8	B	11.000
-	MFV01062200N8	11	-	2	-	10	6,2	2 ÷ 7,5	A	1.000

1  
2  
3  
4  
5  
6  
7  
8  
9  
10  
11  
12  
13  
14  
15  
16  
17  
18  
19  
20

**MATERIAL**

PA6.6 (Polyamide)

**COLOUR**

Black

**SELF-EXTINGUISHING**

UL 94 V-2

**USE**

Particularly suited in applications where the rivet needs to be removed.

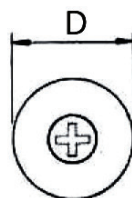
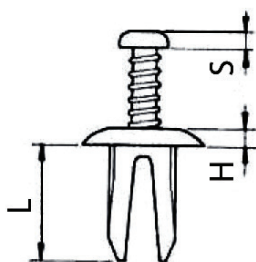

Code 	D	S	H	L	Panel hole	Panel thickness	Package (pcs)
MFV03062300N8	12,8	3	2	12	6,2 ÷ 6,5	3 ÷ 6	5.000
MFV03080600N8	18	2	2	19	8	6 ÷ 14	2.500
MFV03100600N8	18	2	2	19	10	6 ÷ 14	2.500
MFV03050380N8	12	3	1,5	11	5	3,8 ÷ 6	6.000